

DPC-MP727/MP922

SERVICE MANUAL

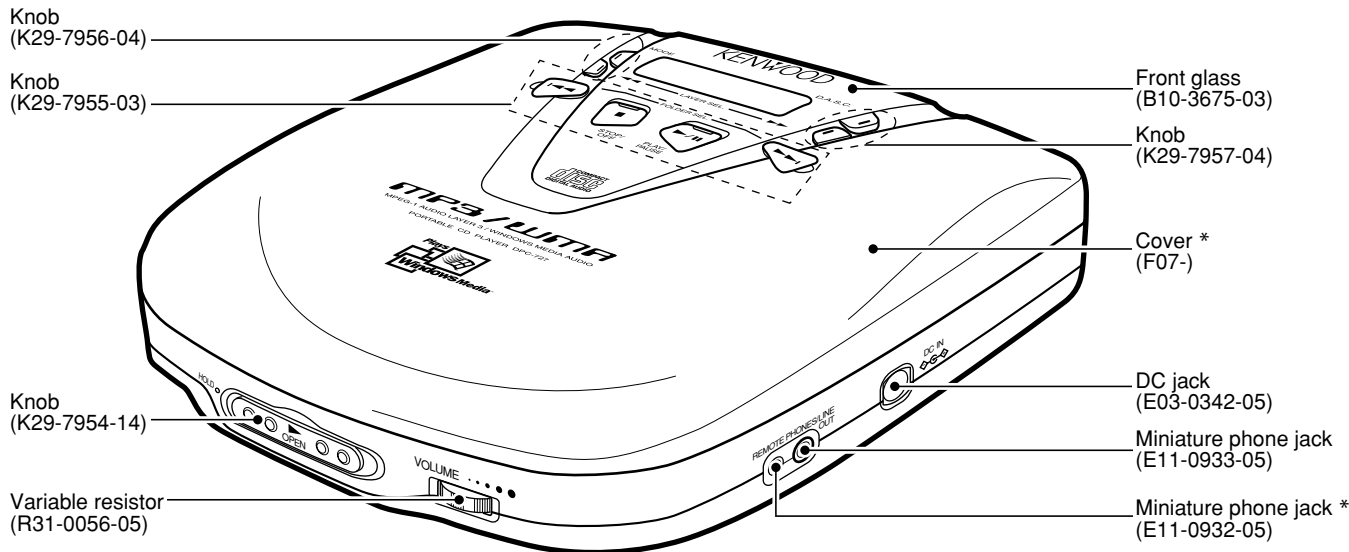

SPECIFICATIONS

Standards

Signal reading formatNon-contact signal reading (semi-conductor laser)

Characteristics

Frequency characteristics20Hz to 20kHz, ±3dB
 Headphone output (16 Ω, 1kHz)9mW + 9mW
 LINE OUT output level/impedanceMAX 0.85V/10kΩ

Power supply

External DC supplyDC 4.5 to 5.1V
 Size AA alkaline batteries available on the open market (LR6/AA x 2 or 4)DC 3V
 Rechargeable batteries (NB-150 x 2)DC 2.4V
 Maximum external dimensions (width x height x depth)129mm x 32mm x 138mm
 (5-1/16" x 1-1/4" x 5-7/16")
 Weight (net)260g (0.6lb)

Battery life expectancy (during continual repeated playback)

Battery	When D.A.S.C. is off	When D.A.S.C. is on	During MP3/WMA file playback
Size AA alkaline batteries available on the open market (LR6/AA x 2)	Approximately 9 hours	Approximately 10 hours	Approximately 10 hours
Size AA alkaline batteries available on the open market (LR6/AA x 4)	Approximately 18 hours	Approximately 22 hours	Approximately 22 hours
Rechargeable battery (NB-150 x 2)	Approximately 7 hours	Approximately 8 hours	Approximately 8 hours

The standard accessories vary depending on the model of the unit.

The accessories which are not standard are optionally available. For details, please consult your dealer.

Note:

KENWOOD follows a policy of continuous advancements in development. For this reason specifications may be changed without notice.

* Refer to parts list on page 15.

In compliance with Federal Regulations, following are reproduction of labels on, or inside the product relating to laser product safety.

KENWOOD-Crop. certifies this equipment conforms to DHHS Regulations No.21 CFR 1040. 10, Chapter 1, Subchapter J.
DANGER : Laser radiation when open and interlock defeated. AVOID DIRECT EXPOSURE TO BEAM.



DPC-MP727/MP922

CONTENTS / ACCESSORIES / CAUTIONS

Contents

SPECIFICATIONS	Cover	PC BOARD	8
CONTENTS / ACCESSORIES / CAUTIONS.....	2	SCHEMATIC DIAGRAM	10
CIRCUIT DESCRIPTION.....	3	EXPLODED VIEW	14
TEST MODE	6	PARTS LIST	15
ADJUSTMENT	7		

Accessories

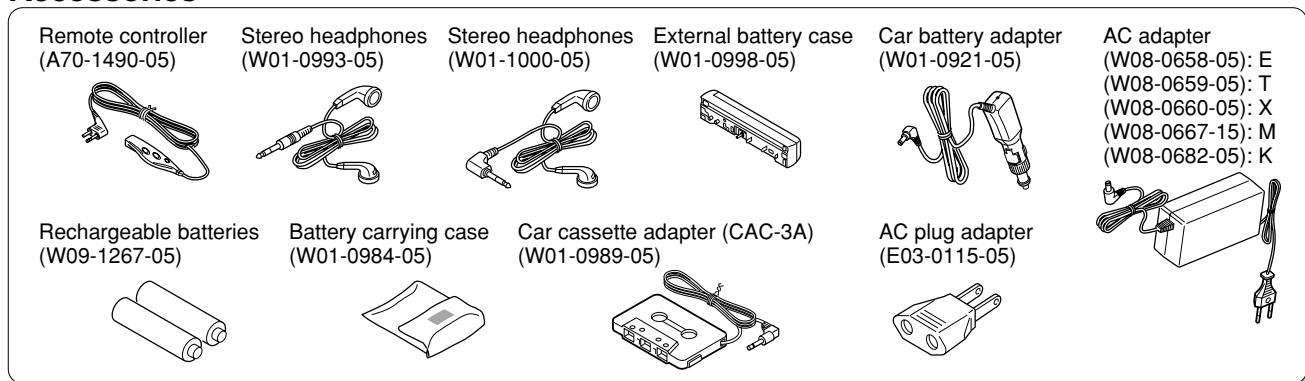

Cautions

Media that can be played back with this equipment

Usable media apart from audio CDs (CD-DA)
Usable media : CD-ROM, CD-R, CD-RW
Usable formats : ISO9660 level 1 and level 2
(excluding expanded formats)
Files that can be played back: MP3 and WMA files

Creating media for playing back on this equipment

Compressing MP3 and WMA files
Please set up the transfer bit rate setting for the compression software when compressing MP3 and WMA files as follows:
MP3 Files : 128kbps recommended (32kbps-320kbps)
WMA Files : 128kbps recommended (64kbps-160kbps)
● This unit is compatible with 32kHz, 44.1kHz (recommended) and 48kHz sampling frequencies.

Categorizing folders

As MP3 and WMA files are compressed into high-quality sound files at an extremely high rate of compression, it is possible to record several times more tracks than audio CDs onto a single medium. It is therefore convenient to split the tracks into different folders by genre, artist or album for retrieval and repeat playback purposes.
● A maximum of 23 folders or a maximum of 200 files can be stored on a single media.
● There are cases where it is not possible to save folders in the desired sequence depending on the software being used.

Naming files

Single-byte characters between A and Z, single-byte numerals between 0 and 9, and the single-byte underscore (_) can be used when naming files. A maximum of twelve characters can be displayed. Ensure that the ".MP3" (MP3 files) or ".WMA" (WMA files) extension logs are attached to all file names.
● Never add the MP3 or WMA extension logs to any files other than MP3 and WMA files. If the MP3 or WMA extension logs are added to any files other than MP3 and WMA files, the equipment will assume that they can be played back, and this will produce loud noises in the headphones, resulting in damage of adverse effects.

Hint for when naming folders and files

When media containing MP3 and WMA files are played back on this equipment, the sequence in which each track is played back will be the same as the sequence in which they were saved. It is possible to set up the playback sequence by adding numbers from between 01 and 99 to the front of the folder and the file name when saving the file.
● There are cases where it is not possible to save files in the desired sequence depending on the software being used.

Additional information

Depending on the MP3 and WMA compression software in use, it is possible to save track titles, artist names and other information together with each sound file as additional information. Although it is possible to display pre-recorded title and artist information with this information, it is necessary to ensure that this information has been entered in single-byte alphanumericals (Up to a maximum of 30 alphanumericals for each.).
● The method of entering title and artist information will differ in accordance with the compression software. Refer to the compression software's instruction manual or help file.

Confirming media and files

Check to ascertain that MP3 and WMA files can be played back correctly on the personal computer in use prior to saving them onto the media. Check to ensure that the saved file can be played back normally.
● It is not possible to confirm that files can be played back correctly while they are being saved onto the media.

When saving files onto media

Ensure that the session is closed or finalized when data has been written on media. There are cases where media on which the session has not been closed or finalized will not be played back correctly with this equipment.
● There are cases where the folder names and file names will not be displayed correctly depending on the software used to save them.
● Do not store files or folders other than MP3 and WMA on media to be played back with this equipment.
● It is recommended that ten or less sessions are stored when recording MP3 and WMA files onto a medium.
● There are cases where playback is not possible when MP3 and WMA files (CD-ROM) and music CD information (CD-DA) are saved on the same media.

DPC-MP727/MP922

CIRCUIT DESCRIPTION

1. Port Description of Microprocessor

Port No.	Port Name	I/O	Function	ACTIVE	
				H	L
1	P60	O	DSP (IC3) reset output.		
2	P61	-	Unused.		
3	P62	O	DSP (IC3) power down control.	ON	OFF
4	P63	-	Unused.		
5~12	P50~P57	-	Unused.		
13~16	P20~P23	-	Unused.		
17	VDD	-	+3.0v power supply.		
18	PB0	-	Unused.		
19	VSS	-	GND		
20	XI,PB1	-	Unused.		
21	XO	-	Unused.		
22	VDD	-	+3.0v power supply.		
23	OSCI	I	Crystal oscillation circuit input.		
24	OSCO	O	Crystal oscillation circuit output.		
25	MODE	-	Connected to VDD.		
26	MCLK	O	DSP (IC15) command clock signal output.		
27	MDATA	O	DSP (IC15) data signal output.		
28	MLD	O	DSP (IC15) command load signal output.		
29	DSPRST	O	DSP (IC15) reset signal output.		
30	IPFLAG	I	Unused.		
31,32	PCON4,3	-	Unused.		
33	PCON2	O	RF AMP power down control.		
34	AVDD	-	+3.0v analog power supply.		
35	PCON1	O	System power supply control.	ON	
36	AMUTE	O	Audio mute control.	ON	
37	HPMUTE	O	Headphones mute control.		ON
38	RWSEL	O	RF gain control.		
39	STAT	I	Status signal input from DSP (IC15).		
40	ACDET	I	Detection port of AC adaptor.		DETECTED
41	BBST	O	Control port of bass boost.	OFF	ON
42	HOLD	I	Input port of hold switch.	OFF	ON
43	VREF-	-	GND		
44	LBATT	I	Battery level detection port.		
45	VOLUME	I	Input port of volume.		
46	P46	O	Crystal oscillation circuit is stopped when in stop mode(Hi).		
47	P47,WDOOUT	-	Unused.		
48	LEDDRV	-	Unused.		
49	ELDDRV	-	Unused.		
50	CHG	O	Rechargeable active output. Batt. charge ON : H		
51	LCDSD	O	Serial data output for LCD.		
52	LCDRMC	-	Unused.		
53	PB5	-	Unused.		
54	VREF+	-	+3.0v power supply.		
55,56	PB6,7	-	Unused.		
57	MP3 MLD	O	Command load output for MP3.		
58	MP3 RESET	O	Reset output for MP3.		
59	DATA STOP	O	Data signal output for MP3.		
60	P93	-	Unused.		
61	AVSS	-	GND		
62,63	KEY1, 2	I	Key signal input.		
64	KEYEXT	I	Remote control signal input.		
65	RCHDET	I	Detection port for low rechargeable battery. Detected : more than 0.2V		
66	VDD	-	+3.0v power supply.		

DPC-MP727/MP922

CIRCUIT DESCRIPTION

Port No.	Port Name	I/O	Function	ACTIVE	
				H	L
67~69	P70~P72	-	Unused.		
70	3T	I	RF 3Tcompensation.		
71	OFTR	I	Changeover the off track.		
72	P75	-	Unused.		
73	PUP1	I	Pull up port.		
74	PUP2	I	Pull up port.		
75	NMI	I	Pull up port.		
76	BLKCK	I	Sub code block clock signal input. f BLKCK=75Hz(usual playback)		
77	DOOR	I	Detection port of door switch.		
78	LIMIT	I	Detection port of limit switch.		
79	WUP	I	Return signal input from CPU (46pin).		
80	HINT	I	Signal input from DSP (IC3) to return the usual action.		
81	PA5	-	GND		
82	RST	I	Reset signal input.		
83	VDD	-	+3.0v power supply.		
84~91	HD0~HD7	I/O	Data bus (0~7) input/output.		
92	VSS	-	GND		
93	HCNTL0	O	Control command output for reading and writing.		
94	HCNTL1	O	Control command output for reading and writing.		
95	HR/W	O	Read write signal output.		
96	HBIL	O	Interface setting port.		
97	HCS	O	CS signal output.		
98	HAS	O	Interface setting port.		
99	HDS	O	Interface setting port.		
100	HRDY	O	Ready signal output.		

2. Port Description of DSP IC (IC15)

Port No.	Port Name	I/O	Function	ACTIVE	
				H	L
1	DVDD3V	-	DRAM interface power supply.		
2,3	D0,D1	I/O	DRAM data input/output signal (D0,D1).		
4	NEW	O	DRAM writing enable signal.		
5	NRAS	O	DRAM RAS control signal.		
6,7	D2,D3	I/O	DRAM data input/output signal (D2,D3).		
8,9	NCAS(0,1)	O	DRAM CAS control signal (0,1).		
10~19	A8~A3	O	DRAM address signal (A8~A3).		
20	DVSS2	-	Digital ground.		
21	DVDD2	-	Digital power supply.		
22	SPOUT	O	Spindle motor drive signal output.		
23	TRVM	O	Traverse drive positive output.		
24	TRVP	O	Traverse drive negative output.		
25	TRM	O	Tracking drive positive output.		
26	TRP	O	Tracking drive negative output.		
27	FOM	O	Focus drive positive output.		
28	FOP	O	Focus drive negative output.		
29	FBAL	O	The balance adjustment for the focus error.		
30	TBAL	O	The balance adjustment for the tracking error.		
31	VREF	I	DA reference voltage input.		
32	FE	I	Focus error signal input.		
33	TE	I	Tracking error signal input.		
34	FRENV	I	RF envelope signal input.		
35	OFT	I	Off track signal input.	Off Track	

DPC-MP727/MP922

CIRCUIT DESCRIPTION

Port No.	Port Name	I/O	Function	ACTIVE	
				H	L
36	NRFDET	I	RF detection signal input.		Detected
37	BDO	I	Drop out signal input.	Drop Out	
38	LDON	-	Unused.		
39	ARF	I	RF signal input.		
40	IREF	I	Reference current input.		
41	ADPVCC	I	AD reference voltage input.		
42	DSLFB	O	DSL loop filter output.		
43	DSLFB2	O	DSL unbalance current correction.		
44	PLLF	O	PLL loop filter output.		
45	VCOF	O	Jitter free VCO loop filter terminal.		
46	AVDD2	-	Analog power supply.		
47	AVSS2	-	Analog ground.		
48	OUTL	O	L ch line output.		
49	AVSS1	-	GND		
50	OUTR	O	R ch line output.		
51	AVDD1	-	Analog power supply.		
52	FSEL	I	Noise filter ON/OFF switching input.	Off	On
53	TMOD1	-	Connected to analog ground.		
54	TMOD2	-	Connected to analog ground.		
55	FLAG	-	Unused.		
56	IPFLAG	O	Flag signal output.		
57~59	EXT(0~2)	I/O	Command change over : Expander input/output port (0~2).		
60	TX	-	Unused.		
61	MCLK	I	Microprocessor command clock signal input.		
62	MDATA	I	Microprocessor command data signal input.		
63	MLD	I	Microprocessor command load signal input.		Load
64	BLKCK	O	Sub code block clock signal output. fBLKCK=75Hz(normal playback)		
65	SQCK	I/O	Command change over : Sub code Q register external clock input.		
66	SUBQ	O	Command change over : Sub code Q data output.		
67	DMUTE	I/O	Command change over : Muting input.	Mute	
68	STAT	O	Status signal output.		
69	NRST	I	Reset signal input.		Reset
70	SPPOL	O	Spindle motor drive signal output (polar output).		
71	PMCK	O	88.2kHz clock signal output.		
72	SMCK	-	Unused.		
73	SUBC	-	Unused.		
74	SBCK	-	Connected to digital power supply.		
75	NCLDCK	-	Unused.		
76	NTEST	-	Connected to digital power supply.		
77	X1	I	Crystal oscillation circuit input. f=16.9344MHz		
78	X2	O	Crystal oscillation circuit output. f=16.9344MHz		
79	DVDD1	-	Digital power supply.		
80	DVSS1	-	Digital ground.		

DPC-MP727/MP922

TEST MODE

1. Test Mode

1-1 Setting Method of the Test Mode

The test mode is entered when the AC adaptor is plugged in to DC IN plug while shorting the both test lands using the jumper and so on.

1-2 Starting active contents

Operation	Power on
FL Indication	Indicates "01 test" in the display.
Other	The pick up travels inward in the stop mode.

1-3 Key Operation in the Test Mode

Keys	Display	Operation
PLAY/PAUSE key	05MODE	Tracking servo on. (05 mode)
SKIP-UP key	03MODE	Tracking servo off. (03 mode) * For TE checking.
SKIP-DOWN key (Whenever the key is pressed, the mode is changed.)	07 * * ## 08 * * ## 09 * * ## 10 * * ##	Indicates the auto adjustment value. * * : FG Value ## : FEXP Value (07 Mode) * * : FBAL Value ## : FOFS Value (08 Mode) * * : TG Value ## : TEXP Value (09 Mode) * * : TBAL Value ## : TOFS Value (10 Mode)
STOP key	01TEST	Stop the CD operation.
FF key		The pick up travels outward in the stop mode.
FB key		The pick up travels inward in the stop mode.

1-4 Canceling the Test Mode

- When the "STOP/OFF" key is pressed, the test mode is cancelled.

2. Configuration of Test Land and Adjusting Trimming Pot (VR2)

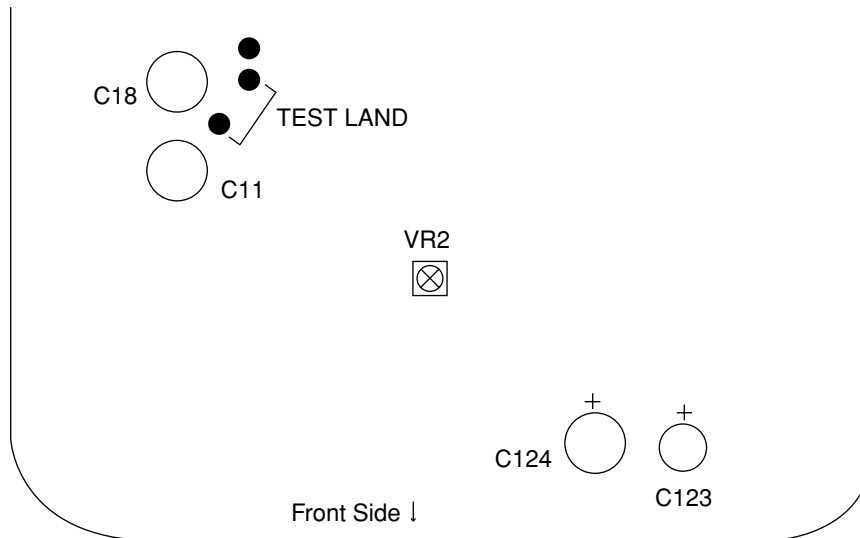

DPC-MP727/MP922

ADJUSTMENT

Adjustment of CD player

No.	ITEM	INPUT SETTING	OUTPUT SETTING	PLAYER SETTING	ALIGNMENT POINT	ALIGNMENT FOR	FIG.
1	+3.0V ADJ.	Plug in an AC adaptor to DC in plug.	Connect a DC voltmeter between C124(positive) and GND.	PLAYBACK	VR2	+3.0V \pm 0.05V	Fig.1

* Above adjustment must be performed when you replaced IC20.

PC BOARD (Component side view)

PC BOARD (Foil side view)

1
2
3
4
5
6
7

X32-3890-11 (J70-1501-12)

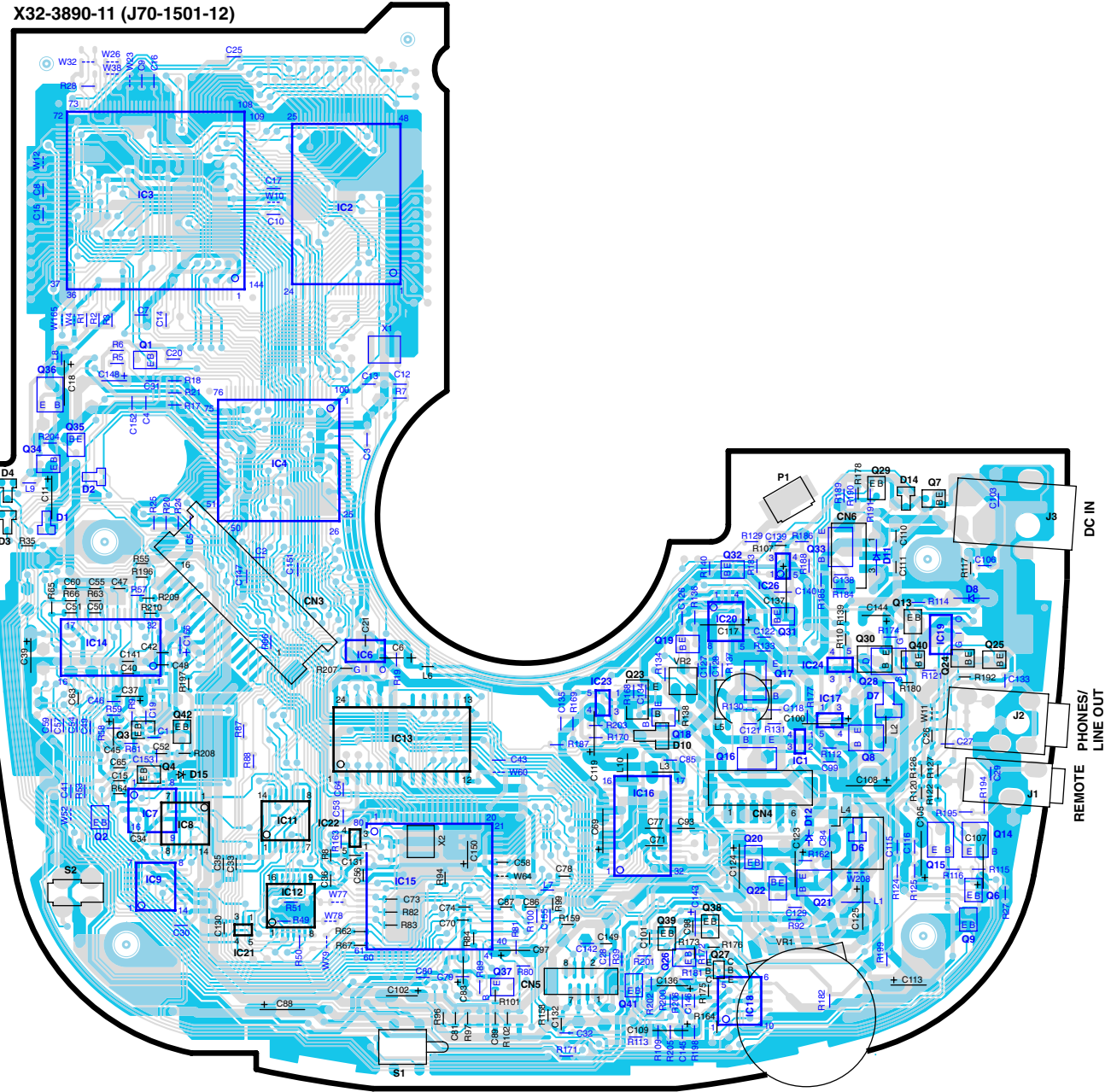

X32-3890-11 (J70-1501-12)

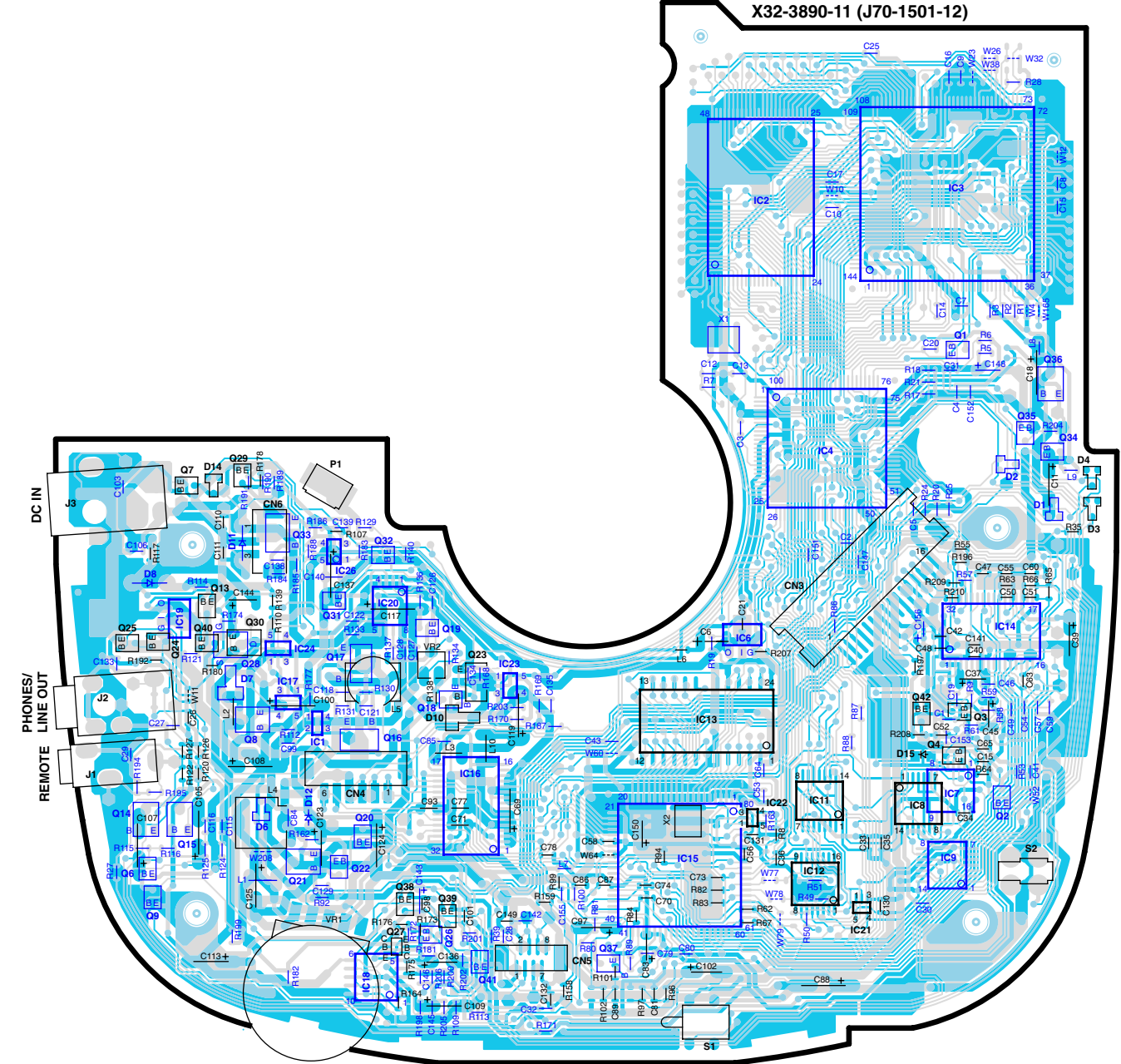

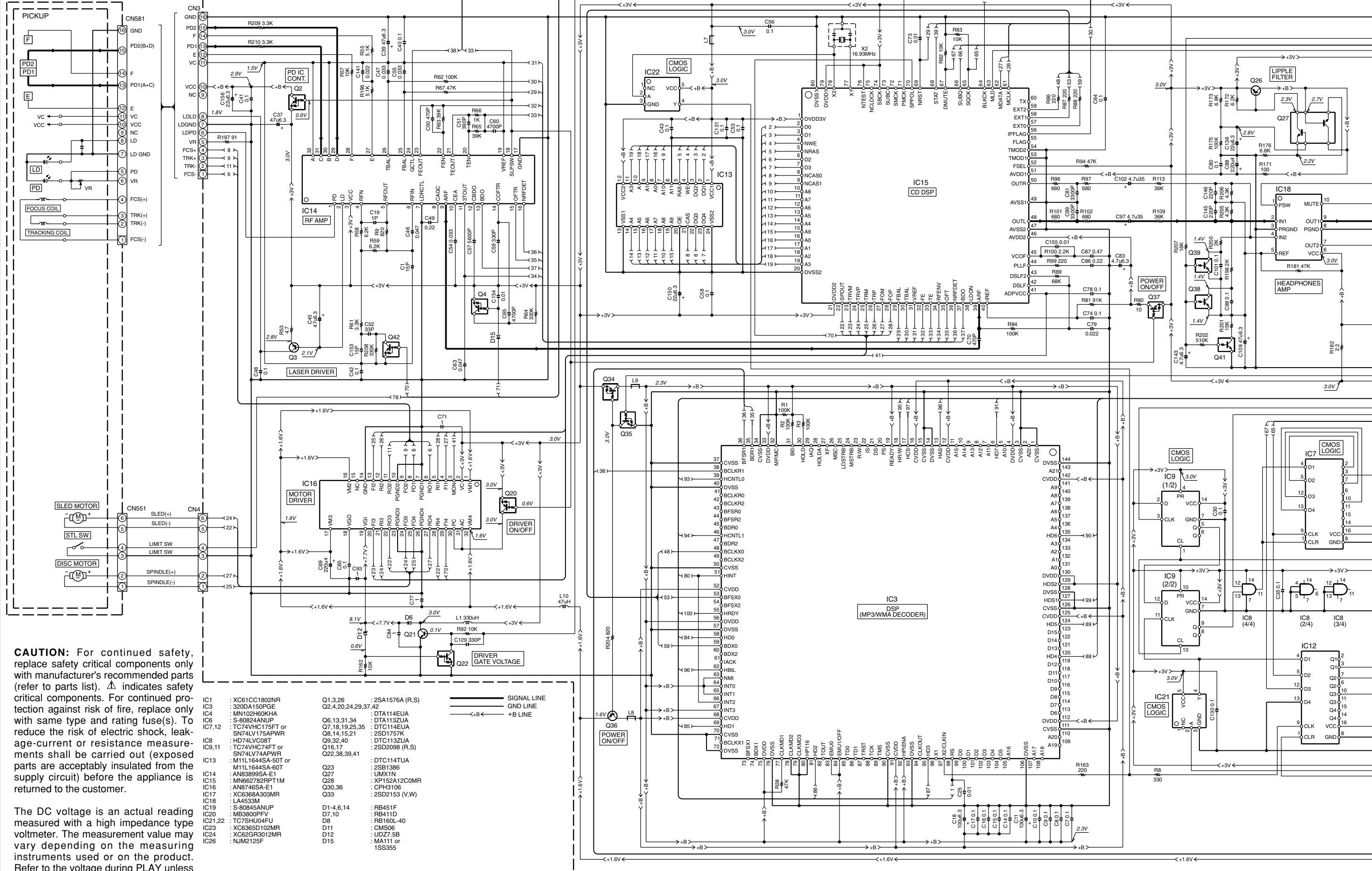

CAUTION: For continued safety, replace safety critical components only with manufacturer's recommended parts (refer to parts list). Δ indicates safety critical components. For continued protection against risk of fire, replace only with same type and rating fuse(s). To reduce the risk of electric shock, leakage-current or resistance measurements shall be carried out (exposed parts are acceptably insulated from the supply circuit) before the appliance is returned to the customer.

IC1 : XC61CC1802NR	Q1,3,26 : 2SA1576A (R,S)	—	SIGNAL LINE
IC3 : 320DA150PGE	Q2,4,20,24,29,37,42	—	GND LINE
IC4 : MN102H60KHA	Q6,13,31,34 : DTA114EUA	—	+B LINE
IC6 : S-80824ANUP	Q7,18,19,25,35 : DTA113ZUA	—	
IC7,12 : TC74VHC175FT or SN74LV175APWR	Q8,14,15,21 : 2SD1757K	—	
IC8 : HD74LV08T	Q9,32,40 : DTC113ZUA	—	
IC9,11 : TC74VHC74FT or SN74LV74APWR	Q16,17 : 2SD2098 (R,S)	—	
IC13 : M11L1644SA-50T or M11L1644SA-60T	Q22,38,39,41 : DTC114TUA	—	
IC14 : AN83899SA-E1	Q23 : 2SB1386	—	
IC15 : MN662782RPT1M	Q27 : UMX1N	—	
IC16 : AN8746SA-E1	Q28 : XP152A12COMR	—	
IC17 : XC6368A303MR	Q30,36 : CPH3106	—	
IC18 : LA453M	Q33 : 2SD2153 (V,W)	—	
IC19 : S-80845ANUP	D1-4,6,14 : RB451F	—	
IC20 : MB3800PFV	D7,10 : RB411D	—	
IC21,22 : TC7SHU04FU	D8 : RB160L-40	—	
IC23 : XC6365D102MR	D11 : CMS06	—	
IC24 : XC62GR3012MR	D12 : UDZ7.5B	—	
IC26 : NJM2125F	D15 : MA111 or 1SS355	—	

The DC voltage is an actual reading measured with a high impedance type voltmeter. The measurement value may vary depending on the measuring instruments used or on the product. Refer to the voltage during PLAY unless otherwise specified; The value shown in () is the voltage measured at the moment of STOP.

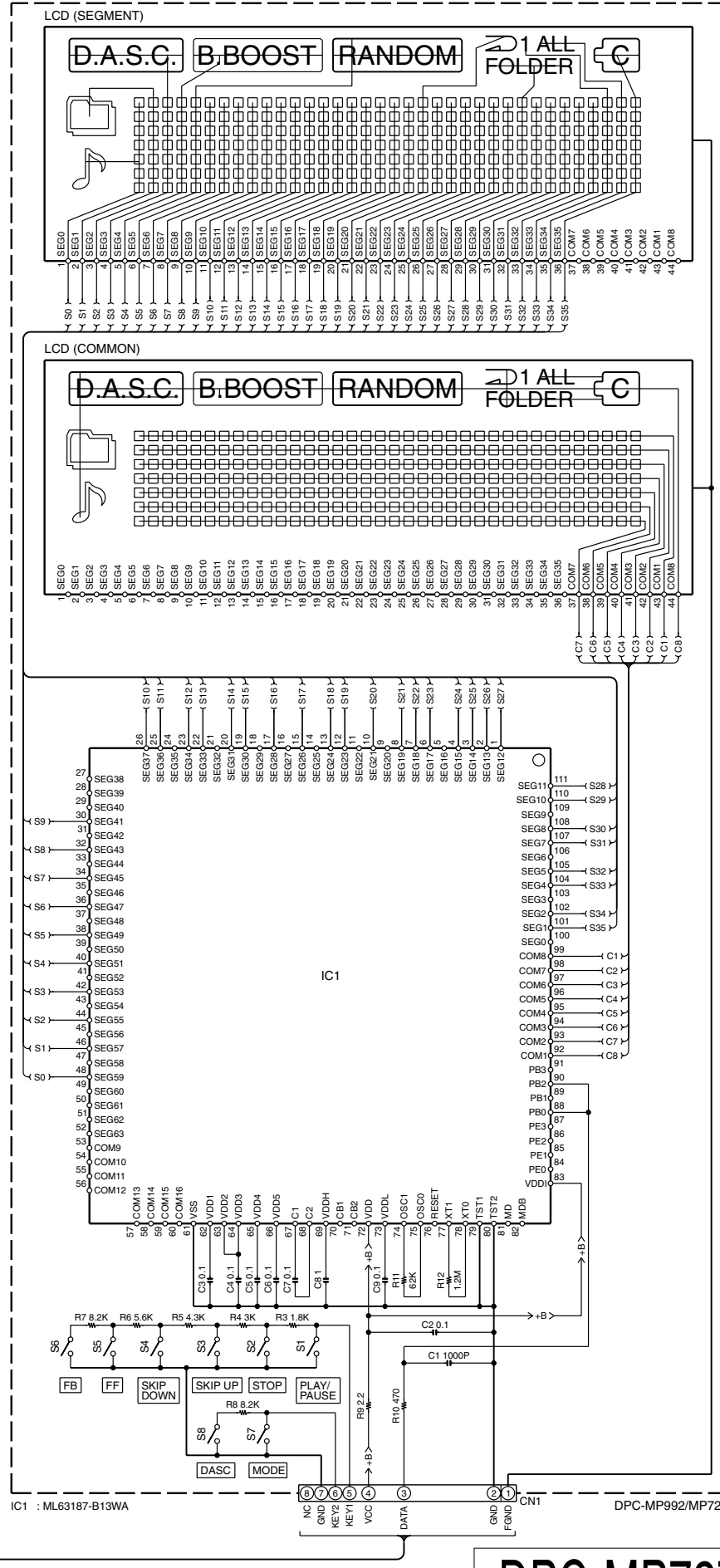
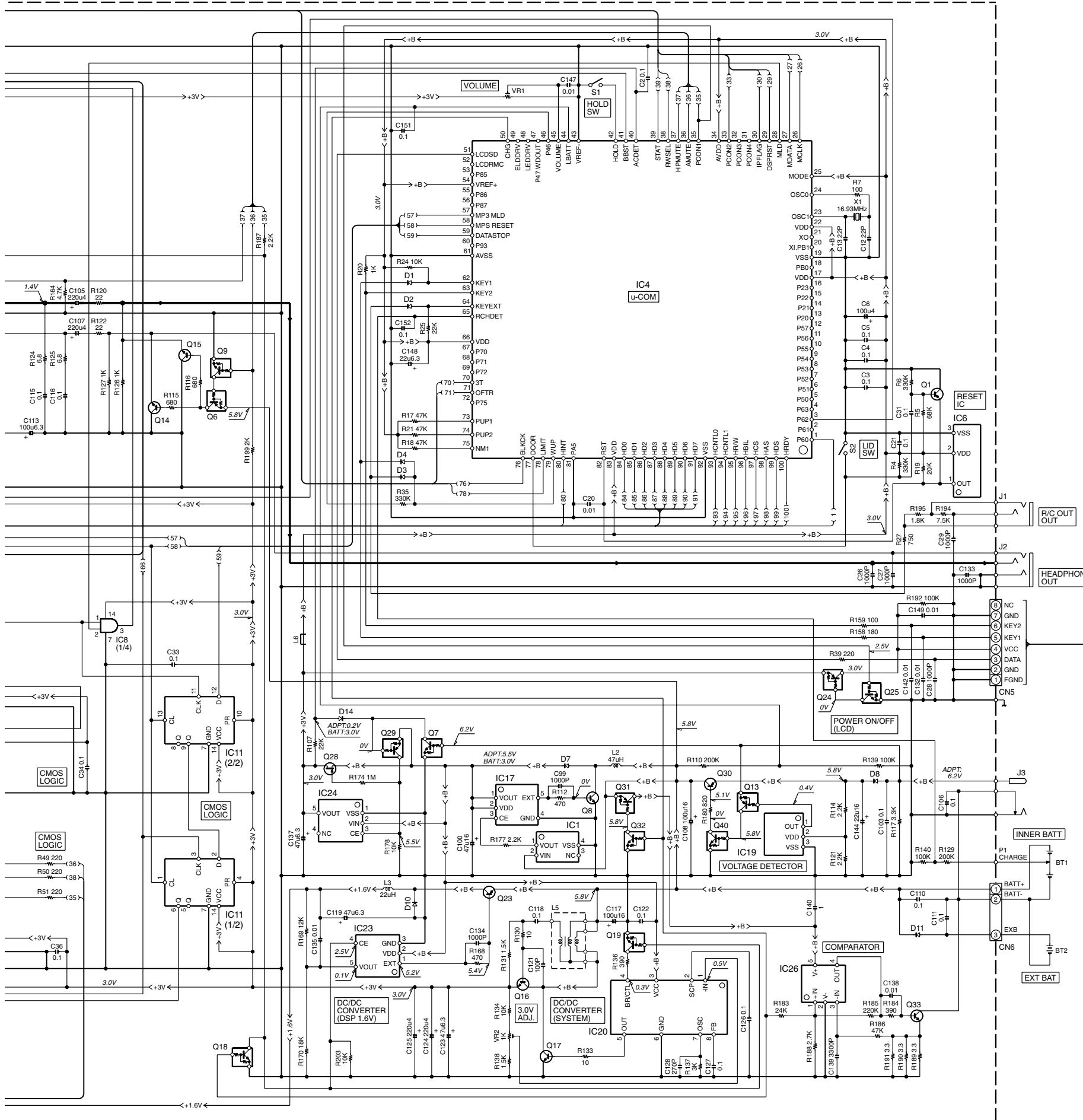

- 2SA1576A
- 2SD2153
- CPH3106
- 2SD1757K
- DTA114EUA
- DTC114EUA
- UMXIN
- RB451F
- HD74LVC08T
- TC7SHU04FU
- MB3800PFV
- TC74VHC74FT

DPC-MP727/MP922

EXPLODED VIEW

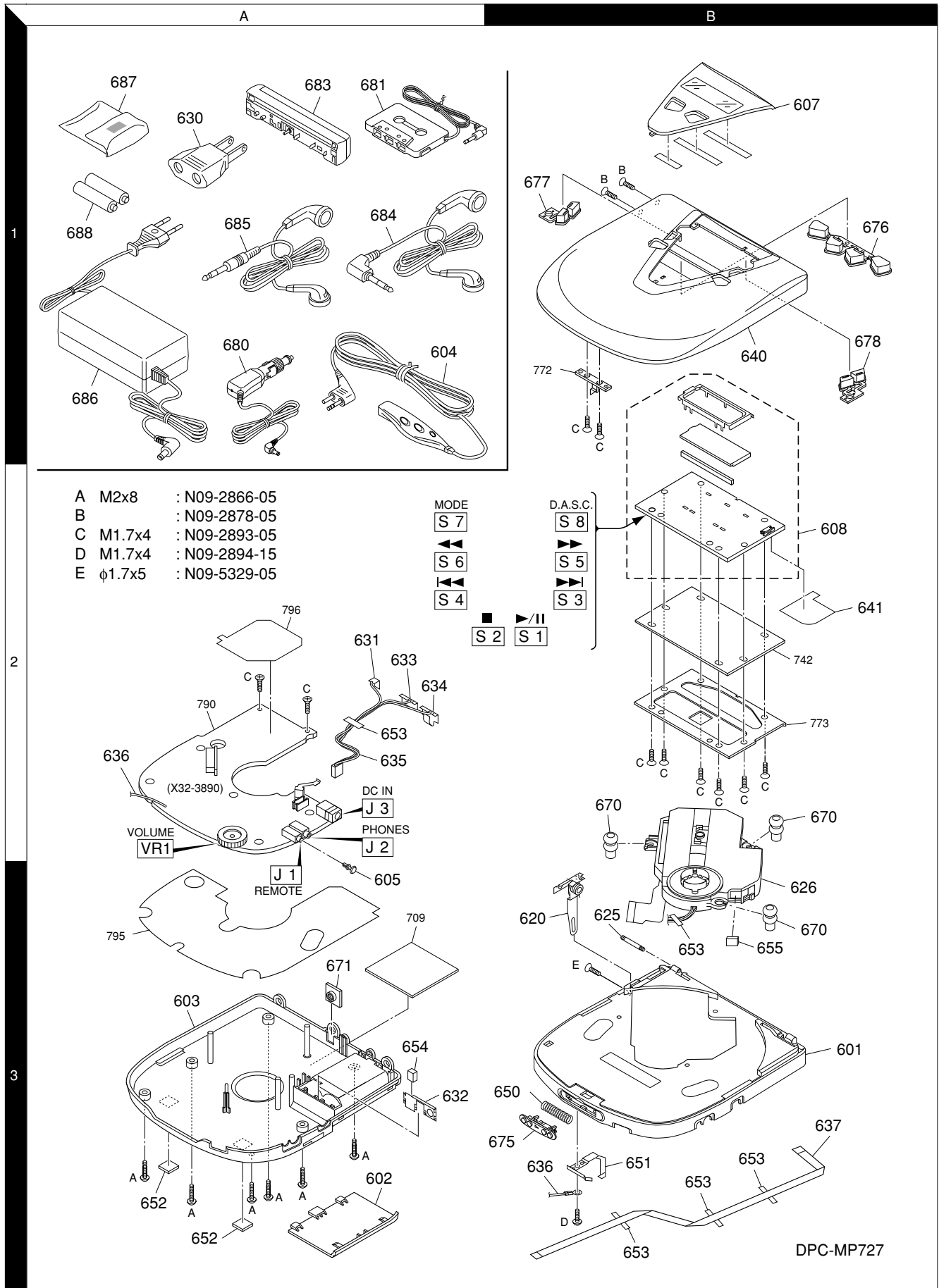

* New Parts

Parts without **Parts No.** are not supplied.
Les articles non mentionnés dans le **Parts No.** ne sont pas fournis.
Teile ohne **Parts No.** werden nicht geliefert.

①

Ref. No	Address	New Parts	Parts No.	Description	Destination	Remarks
DPC-MP727 : 7/DPC-MP922 : 9						
601	3B	*	A02-2998-01	PLASTIC CABINET		
602	3A	*	A09-1217-03	BATTERY COVER		
603	3A	*	A10-3541-01	CHASSIS		
604	1A	*	A70-1490-05	REMOTE CONTROLLER ASSY	M7T7E7	
605	3A	*	B09-0293-05	CAP	K7X7	
605	3A	*	B09-0293-05	CAP	9	
607	1B	*	B10-3675-03	FRONT GLASS		
608	2B	*	B38-0245-05	LCD DISPLAY ASSY		
			B46-0100-50	WARRANTY CARD	XTE	
		*	B46-0332-03	WARRANTY CARD	K	
		*	B46-0347-03	WARRANTY CARD	K	
		*	B58-0965-13	CAUTION CARD (PL)	XT	
		*	B58-0966-13	CAUTION CARD (PL)	ME	
		*	B58-0967-03	CAUTION CARD (PL)	K	
		*	B58-1823-04	CAUTION CARD	K	
		*	B60-4989-00	INSTRUCTION MANUAL(EN)	KMXT	
		*	B60-4990-00	INSTRUCTION MANUAL(FR)	KE	
		*	B60-4991-00	INSTRUCTION MANUAL(TC)	M7	
		*	B60-4992-00	INSTRUCTION MANUAL(GE)	E	
		*	B60-4993-00	INSTRUCTION MANUAL(NE)	E	
		*	B60-4994-00	INSTRUCTION MANUAL(ES)	E	
		*	B60-4995-00	INSTRUCTION MANUAL(IT)	E	
		*	B60-4996-00	INSTRUCTION MANUAL(AR)	M	
620	3B	*	D10-3988-04	ARM ASSY		
625	3B	*	D21-1661-04	SHAFT		
626	3B	*	D40-1735-05	MECHANISM ASSY		
630	1A	*	E03-0115-05	AC PLUG ADAPTER	M	
631	2A	*	E23-1703-04	TERMINAL		
632	3A	*	E23-1732-14	TERMINAL		
633	2A	*	E23-1733-14	TERMINAL		
634	2A	*	E23-1845-04	TERMINAL		
635	2A	*	E35-2861-15	WIRING HARNESS		
636	2A,3B	*	E35-2862-05	WIRING HARNESS		
637	3B	*	E35-2884-05	WIRING HARNESS		
640	1B	*	F07-1742-11	COVER	7	
640	1B	*	F07-1748-11	COVER	9	
641	2B	*	F19-1110-04	BLIND PLATE		
650	3B	*	G01-3929-14	COMPRESSION SPRING		
651	3B	*	G02-1724-04	FLAT SPRING		
652	3A	*	G13-2508-04	CUSHION		
653	2A,3B	*	G10-0582-04	NON-WOVEN FABRIC		
654	3A	*	G11-2839-04	CUSHION		
655	3B	*	G11-2842-04	CUSHION		
		*	H25-0336-04	PROTECTION BAG		
		*	H50-4082-03	ITEM CARTON CASE	K7	
		*	H50-4083-03	ITEM CARTON CASE	M7	
		*	H50-4084-03	ITEM CARTON CASE	E9	
		*	H50-4084-03	ITEM CARTON CASE	K9X9T9	
		*	H50-4085-03	ITEM CARTON CASE	M9	
		*	H50-4086-03	ITEM CARTON CASE	T7E7	
		*	H50-4087-03	ITEM CARTON CASE	X7	

L: Scandinavia K: USA P: Canada R: Mexico C: China I: Malaysia
Y: PX(Far East,Hawaii) T: England E: Europe G: Germany V: China(Shanghai)
Y: AAFES(Europe) X: Australia Q: Russia H: Korea M: Other Areas Δ indicates safety critical components.

* New Parts

Parts without **Parts No.** are not supplied.
Les articles non mentionnés dans le **Parts No.** ne sont pas fournis.
Teile ohne **Parts No.** werden nicht geliefert.

②

Ref. No	Address	New Parts	Parts No.	Description	Destination	Remarks
670	2B,3B	*	J02-1515-05	INSULATOR		
671	3A	*	J21-5920-04	MOUNTING HARDWARE		
675	3B	*	K29-7954-14	KNOB		
676	1B	*	K29-7955-03	KNOB		
677	1B	*	K29-7956-04	KNOB		
678	1B	*	K29-7957-04	KNOB		
680	1A	*	W01-0921-05	ADAPTER	9	
681	1A	*	W01-0989-05	ADAPTER		
683	1A	*	W01-0998-05	BATTERY CASE		
684	1A	*	W01-1000-05	STEREO HEADPHONE	K7X7	
684	1A	*	W01-1000-05	STEREO HEADPHONE	9	
685	1A	*	W01-0993-05	STEREO HEADPHONE	M7T7E7	
Δ 686	1A	*	W08-0658-05	AC ADAPTER	E	
Δ 686	1A	*	W08-0659-05	AC ADAPTER	T	
Δ 686	1A	*	W08-0660-05	AC ADAPTER	X	
Δ 686	1A	*	W08-0667-15	AC ADAPTER	M	
Δ 686	1A	*	W08-0682-05	AC ADAPTER	K	
687	1A	*	W01-0984-05	BATTERY CARRYING CASE	M7X7	
688	1A	*	W09-1267-05	RECHARGEABLE BATTERY	M7X7	
CONTROL (X32-3890-11)						
C1			CC73GCH1H150J	CHIP C	15PF	J
C2 -5			CK73GB1C104K	CHIP C	0.10UF	K
C6			C92-0170-05	TANTAL	100UF	4WV
C7 -10			CK73GB1C104K	CHIP C	0.10UF	K
C11		*	CE32AP0J101M	CHIP EL	100UF	6.3WV
C12,13			CC73GCH1H220J	CHIP C	22PF	J
C14 -17			CK73GB1C104K	CHIP C	0.10UF	K
C18		*	CE32AP0J101M	CHIP EL	100UF	6.3WV
C19			CC73GCH1H010C	CHIP C	1.0PF	C
C20			CK73GB1E103K	CHIP C	0.010UF	K
C21			CK73GB1C104K	CHIP C	0.10UF	K
C25			CK73GB1E103K	CHIP C	0.010UF	K
C26 -29			CK73GB1H102K	CHIP C	1000PF	K
C30,31			CK73GB1C104K	CHIP C	0.10UF	K
C33 -36			CK73GB1C104K	CHIP C	0.10UF	K
C37			C92-0589-05	CHIP-TAN	47UF	6.3WV
C39			CE32AP0J470M	CHIP EL	47UF	6.3WV
C40 -43			CK73GB1C104K	CHIP C	0.10UF	K
C45			C92-0589-05	CHIP-TAN	47UF	6.3WV
C46			CK73GB1C473K	CHIP C	0.047UF	K
C47			CK73GB1C333K	CHIP C	0.033UF	K
C48			CK73GB1C104K	CHIP C	0.10UF	K
C49			CK73GF1C224Z	CHIP C	0.22UF	Z
C50			CC73GCH1H471J	CHIP C	470PF	J
C51			CC73GCH1H391J	CHIP C	390PF	J
C52			CC73GCH1H330J	CHIP C	33PF	J
C53			CK73GB1C104K	CHIP C	0.10UF	K
C54,55			CK73GB1C333K	CHIP C	0.033UF	K
C56			CK73GB1C104K	CHIP C	0.10UF	K
C57			CK73GB1H562K	CHIP C	5600PF	K
C58			CK73GB1C104K	CHIP C	0.10UF	K
C59			CC73GCH1H330J	CHIP C	33PF	J
C60			CK73GB1H472K	CHIP C	4700PF	K
C63			CK73GB1C473K	CHIP C	0.047UF	K

L: Scandinavia K: USA P: Canada R: Mexico C: China I: Malaysia
Y: PX(Far East,Hawaii) T: England E: Europe G: Germany V: China(Shanghai)
Y: AAFES(Europe) X: Australia Q: Russia H: Korea M: Other Areas Δ indicates safety critical components.

PARTS LIST DPC-MP727/MP922

* New Parts

Parts without **Parts No.** are not supplied.Les articles non mentionnés dans le **Parts No.** ne sont pas fournis.Teile ohne **Parts No.** werden nicht geliefert.

③

Ref. No	Add-ress	New Parts	Parts No.	Description	Desti-nation	Re-marks
C64			CK73GB1C104K	CHIP C	0.10UF	K
C65			CK73GB1H472K	CHIP C	4700PF	K
C69			CE32AP0G221M	CHIP EL	220UF	4.0WV
C70			CC73GCH1H471J	CHIP C	470PF	J
C71			CK73FF1C105Z	CHIP C	1.0UF	Z
C73			CK73GB1E103K	CHIP C	0.010UF	K
C74			CK73GB1C104K	CHIP C	0.10UF	K
C77			CK73FF1C105Z	CHIP C	1.0UF	Z
C78			CK73GB1C104K	CHIP C	0.10UF	K
C79			CK73GB1E223K	CHIP C	0.022UF	K
C80			CK73GB1C104K	CHIP C	0.10UF	K
C81			CK73GB1H332K	CHIP C	3300PF	K
C83			C92-0507-05	CHIP-TAN	4.7UF	6.3WV
C84			CK73FF1C105Z	CHIP C	1.0UF	Z
C85			CK73GB1C104K	CHIP C	0.10UF	K
C86			CK73GF1C224Z	CHIP C	0.22UF	Z
C87			CK73GF1A474Z	CHIP C	0.47UF	Z
C88			CE32AP0G221M	CHIP EL	220UF	4.0WV
C89			CK73GB1H332K	CHIP C	3300PF	K
C93			CK73FF1C105Z	CHIP C	1.0UF	Z
C97			CE32AP1V4R7M	CHIP EL	4.7UF	35WV
C98			CK73GB1C104K	CHIP C	0.10UF	K
C99			CK73GB1H102K	CHIP C	1000PF	K
C100			CE32AP1C470M	CHIP EL	47UF	16WV
C101			CK73GB1C104K	CHIP C	0.10UF	K
C102			CE32AP1V4R7M	CHIP EL	4.7UF	35WV
C103			CK73GB1C104K	CHIP C	0.10UF	K
C105			CE32AP0G221M	CHIP EL	220UF	4.0WV
C106			CK73GB1C104K	CHIP C	0.10UF	K
C107			CE32AP0G221M	CHIP EL	220UF	4.0WV
C108			CE32AP1C101M	CHIP EL	100UF	16WV
C109			CE32AP0J470M	CHIP EL	47UF	6.3WV
C110,111			CK73GB1C104K	CHIP C	0.10UF	K
C113		*	CE32AP0J101M	CHIP EL	100UF	6.3WV
C115,116			CK73GB1C104K	CHIP C	0.10UF	K
C117			CE32AP1C101M	CHIP EL	100UF	16WV
C118			CK73GB1C104K	CHIP C	0.10UF	K
C119		*	C92-0234-05	TANTAL	47UF	6.3WV
C121			CC73GCH1H101J	CHIP C	100PF	J
C122			CK73GB1C104K	CHIP C	0.10UF	K
C123		*	C92-0233-05	ELECTRO	47UF	6.3WV
C124,125			CE32AP0G221M	CHIP EL	220UF	4.0WV
C126,127			CK73GB1C104K	CHIP C	0.10UF	K
C128			CC73GCH1H271J	CHIP C	270PF	J
C129			CC73GCH1H331J	CHIP C	330PF	J
C130,131			CK73GB1C104K	CHIP C	0.10UF	K
C132			CK73GB1E103K	CHIP C	0.010UF	K
C133,134			CK73GB1H102K	CHIP C	1000PF	K
C135			CK73GB1E103K	CHIP C	0.010UF	K
C136			CE32AP0J220M	CHIP EL	22UF	6.3WV
C137		*	C92-0234-05	TANTAL	47UF	6.3WV
C138			CK73GB1E103K	CHIP C	0.010UF	K
C139			CK73GB1H332K	CHIP C	3300PF	K
C140			CK73FF1C105Z	CHIP C	1.0UF	Z
C141			CK73GB1E223K	CHIP C	0.022UF	K

L : Scandinavia

K : USA

P : Canada

R : Mexico

C : China

I : Malaysia

Y : PX(Far East,Hawaii)

T : England

E : Europe

G : Germany

V : China(Shanghai)

Y : AAFES(Europe)

X : Australia

Q : Russia

H : Korea

M : Other Areas

⚠ indicates safety critical components.

* New Parts

Parts without **Parts No.** are not supplied.Les articles non mentionnés dans le **Parts No.** ne sont pas fournis.Teile ohne **Parts No.** werden nicht geliefert.

④

Ref. No	Add-ress	New Parts	Parts No.	Description	Desti-nation	Re-marks
C142			CK73GB1E103K	CHIP C	0.010UF	K
C143			C92-0507-05	CHIP-TAN	4.7UF	6.3WV
C144			C92-0206-05	TANTAL	22UF	16WV
C145,146			CC73GCH1H221J	CHIP C	220PF	J
C147			CK73GB1E103K	CHIP C	0.010UF	K
C148			C92-0712-05	CHIP-TAN	22UF	6.3WV
C149			CK73GB1E103K	CHIP C	0.010UF	K
C150			C92-0712-05	CHIP-TAN	22UF	6.3WV
C151,152			CK73GB1C104K	CHIP C	0.10UF	K
C153			CC73GCH1H150J	CHIP C	15PF	J
C154,155			CK73GB1E103K	CHIP C	0.010UF	K
C156			C92-0712-05	CHIP-TAN	22UF	6.3WV
CN3			E40-9450-05	FLAT CABLE CONNECTOR		
CN4		*	E40-8790-05	PIN ASSY		
CN5		*	E40-8791-05	FLAT CABLE CONNECTOR		
CN6		*	E40-8789-05	PIN ASSY		
J1		*	E11-0932-05	MINIATURE PHONE JACK(3P)		
J2		*	E11-0933-05	MINIATURE PHONE JACK(4P)		
J3			E03-0342-05	DC JACK		
L1		*	L33-1622-05	CHOKE COIL		
L2		*	L33-1619-05	CHOKE COIL		
L3		*	L33-1623-05	CHOKE COIL		
L5		*	L33-1618-05	CHOKE COIL		
L6 -9			L92-0140-05	CHIP FERRITE		
L10		*	L33-1619-05	CHOKE COIL		
X1 ,2			L78-0704-05	RESONATOR	(16.93M)	
R1 -3			RK73GB1J104J	CHIP R	100K	J 1/16W
R4			RK73GB1J334J	CHIP R	330K	J 1/16W
R5			RK73GB1J683J	CHIP R	68K	J 1/16W
R6			RK73GB1J334J	CHIP R	330K	J 1/16W
R7			RK73GB1J101J	CHIP R	100	J 1/16W
R8			RK73GB1J331J	CHIP R	330	J 1/16W
R9			RK73GB1J821J	CHIP R	820	J 1/16W
R17 ,18			RK73GB1J473J	CHIP R	47K	J 1/16W
R19			RK73GB1J203J	CHIP R	20K	J 1/16W
R20			RK73GB1J102J	CHIP R	1.0K	J 1/16W
R21			RK73GB1J473J	CHIP R	47K	J 1/16W
R24			RK73GB1J103J	CHIP R	10K	J 1/16W
R25			RK73GB1J223J	CHIP R	22K	J 1/16W
R27			RK73GB1J751J	CHIP R	750	J 1/16W
R28			RK73GB1J473J	CHIP R	47K	J 1/16W
R35			RK73GB1J334J	CHIP R	330K	J 1/16W
R39			RK73GB1J221J	CHIP R	220	J 1/16W
R49 -51			RK73GB1J221J	CHIP R	220	J 1/16W
R53			RK73GB1J4R7J	CHIP R	4.7	J 1/16W
R55			RK73GB1J512J	CHIP R	5.1K	J 1/16W
R57			RK73GB1J103J	CHIP R	10K	J 1/16W
R58 ,59			RK73GB1J622J	CHIP R	6.2K	J 1/16W
R61			RK73GB1J332J	CHIP R	3.3K	J 1/16W
R62			RK73GB1J104J	CHIP R	100K	J 1/16W
R63			RK73GB1J393J	CHIP R	39K	J 1/16W
R64			RK73GB1J334J	CHIP R	330K	J 1/16W
R65			RK73GB1J393J	CHIP R	39K	J 1/16W

L : Scandinavia

K : USA

P : Canada

R : Mexico

C : China

I : Malaysia

Y : PX(Far East,Hawaii)

T : England

E : Europe

G : Germany

V : China(Shanghai)

Y : AAFES(Europe)

X : Australia

Q : Russia

H : Korea

M : Other Areas

⚠ indicates safety critical components.

* New Parts

Parts without **Parts No.** are not supplied.
Les articles non mentionnés dans le **Parts No.** ne sont pas fournis.
Teile ohne **Parts No.** werden nicht geliefert.

5

Ref. No	Add-ress	New Parts	Parts No.	Description	Desti-nation	Re-marks
R66			RK73GB1J102J	CHIP R 1.0K	J	1/16W
R67			RK73GB1J473J	CHIP R 47K	J	1/16W
R80			RK73GB1J100J	CHIP R 10	J	1/16W
R81			RK73GB1J913J	CHIP R 91K	J	1/16W
R82 ,83			RK73GB1J103J	CHIP R 10K	J	1/16W
R84			RK73GB1J104J	CHIP R 100K	J	1/16W
R86 -88			RK73GB1J221J	CHIP R 220	J	1/16W
R89			RK73GB1J683J	CHIP R 68K	J	1/16W
R92			RK73GB1J103J	CHIP R 10K	J	1/16W
R94			RK73GB1J473J	CHIP R 47K	J	1/16W
R96 ,97			RK73GB1J681J	CHIP R 680	J	1/16W
R99			RK73GB1J221J	CHIP R 220	J	1/16W
R100			RK73GB1J222J	CHIP R 2.2K	J	1/16W
R101, 102			RK73GB1J681J	CHIP R 680	J	1/16W
R107			RK73GB1J223J	CHIP R 22K	J	1/16W
R109			RK73GB1J363J	CHIP R 36K	J	1/16W
R110	*		R92-4503-05	METAL GLAZE 200K	F	
R112			RK73GB1J471J	CHIP R 470	J	1/16W
R113			RK73GB1J363J	CHIP R 36K	J	1/16W
R114			RK73GB1J222J	CHIP R 2.2K	J	1/16W
R115, 116			RK73GB1J681J	CHIP R 680	J	1/16W
R117			RK73GB1J332J	CHIP R 3.3K	J	1/16W
R120			RK73GB1J220J	CHIP R 22	J	1/16W
R121			RK73GB1J222J	CHIP R 2.2K	J	1/16W
R122			RK73GB1J220J	CHIP R 22	J	1/16W
R124, 125			RK73GB1J6R8J	CHIP R 6.8	J	1/16W
R126, 127			RK73GB1J102J	CHIP R 1.0K	J	1/16W
R129	*		R92-4503-05	METAL GLAZE 200K	F	
R130			RK73GB1J100J	CHIP R 10	J	1/16W
R131			RK73GB1J152J	CHIP R 1.5K	J	1/16W
R133			RK73GB1J100J	CHIP R 10	J	1/16W
R134			RK73GB1J103J	CHIP R 10K	J	1/16W
R136			RK73GB1J391J	CHIP R 390	J	1/16W
R137			RK73GB1J302J	CHIP R 3.0K	J	1/16W
R138			RK73GB1J152J	CHIP R 1.5K	J	1/16W
R139, 140			R92-2153-05	METAL GLAZE 100K	F	
R158			RK73GB1J181J	CHIP R 180	J	1/16W
R159			RK73GB1J101J	CHIP R 100	J	1/16W
R162			RK73GB1J103J	CHIP R 10K	J	1/16W
R163			RK73GB1J221J	CHIP R 220	J	1/16W
R164			RK73GB1J472J	CHIP R 4.7K	J	1/16W
R168			RK73GB1J471J	CHIP R 470	J	1/16W
R169			RK73GB1J123J	CHIP R 12K	J	1/16W
R170			RK73GB1J183J	CHIP R 18K	J	1/16W
R171			RK73GB1J101J	CHIP R 100	J	1/16W
R172			RK73GB1J622J	CHIP R 6.2K	J	1/16W
R173			RK73GB1J682J	CHIP R 6.8K	J	1/16W
R174			RK73GB1J105J	CHIP R 1.0M	J	1/16W
R175			RK73GB1J104J	CHIP R 100K	J	1/16W
R176			RK73GB1J682J	CHIP R 6.8K	J	1/16W
R177			RK73GB1J222J	CHIP R 2.2K	J	1/16W
R178			RK73GB1J103J	CHIP R 10K	J	1/16W
R180			RK73GB1J821J	CHIP R 820	J	1/16W
R181			RK73GB1J473J	CHIP R 47K	J	1/16W
R182			RK73GB1J2R2J	CHIP R 2.2	J	1/16W

L : Scandinavia K : USA P : Canada R : Mexico C : China I : Malaysia
 Y : PX(Far East,Hawaii) T : England E : Europe G : Germany V : China(Shanghai)
 Y : AAFES(Europe) X : Australia Q : Russia H : Korea M : Other Areas Δ indicates safety critical components .

* New Parts

Parts without **Parts No.** are not supplied.
Les articles non mentionnés dans le **Parts No.** ne sont pas fournis.
Teile ohne **Parts No.** werden nicht geliefert.

6

Ref. No	Add-ress	New Parts	Parts No.	Description	Desti-nation	Re-marks
R183			RK73GB1J243J	CHIP R 24K	J	1/16W
R184			RK73GB1J391J	CHIP R 390	J	1/16W
R185			RK73GB1J224J	CHIP R 220K	J	1/16W
R186			RK73GB1J473J	CHIP R 47K	J	1/16W
R187			RK73GB1J222J	CHIP R 2.2K	J	1/16W
R188			RK73GB1J272J	CHIP R 2.7K	J	1/16W
R189-191			RK73GB1J3R3J	CHIP R 3.3	J	1/16W
R192			RK73GB1J104J	CHIP R 100K	J	1/16W
R194			RK73GB1J752J	CHIP R 7.5K	J	1/16W
R195			RK73GB1J182J	CHIP R 1.8K	J	1/16W
R196			RK73GB1J512J	CHIP R 5.1K	J	1/16W
R197			RK73GB1J910J	CHIP R 91	J	1/16W
R198-200			RK73GB1J202J	CHIP R 2.0K	J	1/16W
R201			RK73GB1J153J	CHIP R 15K	J	1/16W
R202			RK73GB1J514J	CHIP R 510K	J	1/16W
R203			RK73GB1J103J	CHIP R 10K	J	1/16W
R204			RK73GB1J821J	CHIP R 820	J	1/16W
R205, 206			RK73GB1J432J	CHIP R 4.3K	J	1/16W
R207			RK73GB1J163J	CHIP R 16K	J	1/16W
R208			RK73GB1J334J	CHIP R 330K	J	1/16W
R209, 210			RK73GB1J332J	CHIP R 3.3K	J	1/16W
VR1			R31-0056-05	VARIABLE RESISTOR		
VR2	*		R32-0101-05	SEMI FIXED VARIABLE RESISTOR		
W4			R92-1252-05	CHIP R 0 OHM		
W10 -12			R92-1252-05	CHIP R 0 OHM		
W23			R92-1252-05	CHIP R 0 OHM		
W26			R92-1252-05	CHIP R 0 OHM		
W32			R92-1252-05	CHIP R 0 OHM		
W38			R92-1252-05	CHIP R 0 OHM		
W52			R92-1252-05	CHIP R 0 OHM		
W60			R92-1252-05	CHIP R 0 OHM		
W64			R92-1252-05	CHIP R 0 OHM		
W77 -79			R92-1252-05	CHIP R 0 OHM		
W165			R92-1252-05	CHIP R 0 OHM		
W208			R92-0679-05	CHIP R 0 OHM		
S1	*		S64-0055-05	LEVER SWITCH		
S2			S64-0021-05	LEVER SWITCH		
D1 -4			RB451F	DIODE		
D6			RB451F	DIODE		
D7			RB411D	DIODE		
D8			RB160L-40	DIODE		
D10			RB411D	DIODE		
D11			CMS06	DIODE		
D12			UDZ7.5B	ZENER DIODE		
D14			RB451F	DIODE		
D15			MA111	DIODE		
D15			1SS355	DIODE		
IC1	*		XC61CC1802NR	MOS-IC		
IC3	*		320DA150PGE	MOS-IC		
IC4	*		MN102H60KHA	MI-COM IC		
IC6	*		S-80824ANUP	MOS-IC		
IC7	*		SN74LV175APWR	MOS-IC		
IC7	*		TC74VHC175FT	MOS-IC		
IC8			HD74LVC08T	MOS-IC		

L : Scandinavia K : USA P : Canada R : Mexico C : China I : Malaysia
 Y : PX(Far East,Hawaii) T : England E : Europe G : Germany V : China(Shanghai)
 Y : AAFES(Europe) X : Australia Q : Russia H : Korea M : Other Areas Δ indicates safety critical components .

PARTS LIST

DPC-MP727/MP922

DPC-MP727/MP922

PARTS LIST

7

* New Parts
Parts without **Parts No.** are not supplied.
Les articles non mentionnes dans le **Parts No.** ne sont pas fournis.
Teile ohne **Parts No.** werden nicht geliefert.

Ref. No	Add-ress	New Parts	Parts No.	Description	Desti-nation	Re-marks
IC9		*	SN74LV74APWR	MOS-IC		
IC9			TC74VHC74FT	MOS-IC		
IC11		*	SN74LV74APWR	MOS-IC		
IC11			TC74VHC74FT	MOS-IC		
IC12		*	SN74LV175APWR	MOS-IC		
IC12		*	TC74VHC175FT	MOS-IC		
IC13		*	M11L1644SA-50T	MEMORY IC		
IC13		*	M11L1644SA-60T	MEMORY IC		
IC14		*	AN8399SA-E1	ANALOGUE IC		
IC15		*	MN662782RPT1M	MOS-IC		
IC16		*	AN8746SA-E1	ANALOGUE IC		
IC17		*	XC6368A303MR	ANALOGUE IC		
IC18		*	LA4533M	ANALOGUE IC		
IC19		*	S-80845ANUP	MOS-IC		
IC20			MB3800PFV	ANALOGUE IC		
IC21,22			TC7SHU04FU	MOS-IC		
IC23		*	XC6365D102MR	ANALOGUE IC		
IC24		*	XC62GR3012MR	ANALOGUE IC		
IC26			NJM2125F	ANALOGUE IC		
Q1			2SA1576A(R,S)	TRANSISTOR		
Q2			DTA114EUA	DIGITAL TRANSISTOR		
Q3			2SA1576A(R,S)	TRANSISTOR		
Q4			DTA114EUA	DIGITAL TRANSISTOR		
Q6			DTA113ZUA	DIGITAL TRANSISTOR		
Q7			DTC114EUA	DIGITAL TRANSISTOR		
Q8			2SD1757K	TRANSISTOR		
Q9			DTC113ZUA	DIGITAL TRANSISTOR		
Q13			DTA113ZUA	DIGITAL TRANSISTOR		
Q14, 15			2SD1757K	TRANSISTOR		
Q16, 17			2SD2098(R,S)	TRANSISTOR		
Q18, 19			DTC114EUA	DIGITAL TRANSISTOR		
Q20			DTA114EUA	DIGITAL TRANSISTOR		
Q21			2SD1757K	TRANSISTOR		
Q22		*	DTC114TUA	DIGITAL TRANSISTOR		
Q23			2SB1386	TRANSISTOR		
Q24			DTA114EUA	DIGITAL TRANSISTOR		
Q25			DTC114EUA	DIGITAL TRANSISTOR		
Q26			2SA1576A(R,S)	TRANSISTOR		
Q27			UMX1N	TRANSISTOR		
Q28			XP152A12C0MR	FET		
Q29			DTA114EUA	DIGITAL TRANSISTOR		
Q30			CPH3106	TRANSISTOR		
Q31			DTA113ZUA	DIGITAL TRANSISTOR		
Q32			DTC113ZUA	DIGITAL TRANSISTOR		
Q33			2SD2153(V,W)	TRANSISTOR		
Q34			DTA113ZUA	DIGITAL TRANSISTOR		
Q35			DTC114EUA	DIGITAL TRANSISTOR		
Q36			CPH3106	TRANSISTOR		
Q37			DTA114EUA	DIGITAL TRANSISTOR		
Q38, 39			DTC114TUA	DIGITAL TRANSISTOR		
Q40			DTC113ZUA	DIGITAL TRANSISTOR		
Q41			DTC114TUA	DIGITAL TRANSISTOR		
Q42			DTA114EUA	DIGITAL TRANSISTOR		

L : Scandinavia K : USA P : Canada R : Mexico C : China I : Malaysia
Y : PX(Far East,Hawaii) T : England E : Europe G : Germany V : China(Shanghai)
Y : AAFES(Europe) X : Australia Q : Russia H : Korea M : Other Areas Δ indicates safety critical components.

KENWOOD CORPORATION

14-6 Dogenzaka 1-chome, Shibuya-ku, Tokyo, 150-8501 Japan

KENWOOD SERVICE CORPORATION

P.O. BOX 22745, 2201 East Dominguez St., Long Beach, CA 90801-5745, U.S.A.

KENWOOD ELECTRONICS CANADA INC.

6070 Kestrel Road, Mississauga, Ontario, Canada L5T 1S8

KENWOOD ELECTRONICS LATIN AMERICA S.A.

P.O. BOX 552791, Pso 6 plaza Chase, Cl. 47 y Aquilino de la Guardia Panama, Republic de Panama

KENWOOD ELECTRONICS BRASIL LTDA.

Av. Moema, 170-17, Andar-Cobertura "B", Ed. Maximum Service Center, 04077-020

Moema, Sao Paulo, Sp-Brasil

KENWOOD ELECTRONICS U.K. LIMITED

KENWOOD House, Dwight Road, Watford, Herts., WD1 8EB., United Kingdom

KENWOOD ELECTRONICS BELGIUM N.V.

Meachelsesteenweg 418, B-1930 Zaventem, Belgium

KENWOOD ELECTRONICS DEUTSCHLAND GMBH

Rembrücker Str. 15, 63150 Heusenstamm, Germany

KENWOOD ELECTRONICS FRANCE S.A.

13 Boulevard Ney, 75018 Paris, France

KENWOOD ELECTRONICS ITALIA S.p.a.

Via G. Sirtori, 7/9 20129, Milano, Italy

KENWOOD IBERICA S.A.

Bolivia, 239-08020 Barcelona, Spain

KENWOOD ELECTRONICS AUSTRALIA PTY. LTD.

(A.C.N. 001 499 074)

16 Giffnock Avenue, North Ryde, N.S.W. 2113, Australia

KENWOOD ELECTRONICS (HONG KONG) LTD.

Unit 3712-3724, Level 37, Tower 1, Metroplaza, 223 Hing Fong Road, Kwai Fong N.T., Hong Kong

KENWOOD ELECTRONICS GULF FZE

P.O.Box 61318, Jebel Ali, Dubai, U.A.E.

KENWOOD ELECTRONICS SINGAPORE PTE LTD.

No. 1 Genting Lane #02-02, KENWOOD Building, Singapore, 349544

KENWOOD ELECTRONICS (MALAYSIA) SDN BHD.

#4.01 Level 4, Wisma Academy Lot 4A, Jalan 191 46300 Petaling Jaya Selangor Darul Ehsan

Malaysia

KENWOOD ELECTRONICS (THAILAND) CO., LTD.

2019 New Pechuri Road, Bangkok, Huaykwang, Bangkok, 10320 Thailand